

**RADIAL ENGINEERING LTD.  
3 YEAR TRANSFERABLE WARRANTY**

RADIAL ENGINEERING LTD. ("Radial") warrants this product to be free from defects in material and workmanship and will remedy any such defects free of charge according to the terms of this warranty. Radial will repair or replace (at its option) any defective component(s) of this product (excluding finish and wear and tear on components under normal use) for a period of three (3) years from the original date of purchase. In the event that a particular product is no longer available, Radial reserves the right to replace the product with a similar product of equal or greater value. To make a request or claim under this limited warranty, the product must be returned prepaid in the original shipping container (or equivalent) to Radial or to an authorized Radial repair center and you must assume the risk of loss or damage. A copy of the original invoice showing date of purchase and the dealer name must accompany any request for work to be performed under this limited warranty. This limited warranty shall not apply if the product has been damaged due to abuse, misuse, misapplication, accident or as a result of service or modification by any other than an authorized Radial repair center.

THERE ARE NO EXPRESSED WARRANTIES OTHER THAN THOSE ON THE FACE HEREOF AND DESCRIBED ABOVE. NO WARRANTIES WHETHER EXPRESSED OR IMPLIED, INCLUDING BUT NOT LIMITED TO, ANY IMPLIED WARRANTIES OF MERCHANTABILITY OR FITNESS FOR A PARTICULAR PURPOSE SHALL EXTEND BEYOND THE RESPECTIVE WARRANTY PERIOD DESCRIBED ABOVE OF THREE YEARS. RADIAL SHALL NOT BE RESPONSIBLE OR LIABLE FOR ANY SPECIAL, INCIDENTAL OR CONSEQUENTIAL DAMAGES OR LOSS ARISING FROM THE USE OF THIS PRODUCT. THIS WARRANTY GIVES YOU SPECIFIC LEGAL RIGHTS, AND YOU MAY ALSO HAVE OTHER RIGHTS, WHICH MAY VARY DEPENDING ON WHERE YOU LIVE AND WHERE THE PRODUCT WAS PURCHASED.

www.radialeng.com



Radial Engineering Ltd.  
1638 Kebet Way, Port Coquitlam BC V3C 5W9  
tel: 604-942-1001 • fax: 604-942-1010  
email: info@radialeng.com • web: www.radialeng.com

Radial 8cx and 8cx Owner's Manual - Part #R870 1185 • V1.0  
Specifications and appearance are subject to change without notice.



## 8ox and 8cx Owner's Manual

Eight Channel • Transformer Isolated • Microphone Splitters



### 8ox Rackmount

R800 8003 - Radial Transformers  
R800 8004 - Jensen Transformers



### 8cx Install

R800 8002 - Radial Transformers  
R800 8001 - Jensen Transformers

Radial Engineering Ltd.  
1638 Kebet Way, Port Coquitlam BC V3C 5W9  
tel: 604-942-1001 • fax: 604-942-1010  
email: info@radialeng.com • web: www.radialeng.com  
Specifications and appearance are subject to change without notice.



# 8ox and 8cx Owner's Manual

## Eight Channel • Transformer Isolated • Microphone Splitters

Table of Contents	Page
8ox Introduction .....	1
8ox Design Concept .....	2
Basics - What is a Splitter .....	2
How a Transformer Works.....	2
What is a Ground Loop .....	2
Signal Flow Block Diagram .....	3
Feature Set.....	4
Applications .....	6
Grounding Options .....	7
8cx Introduction .....	8
8cx Installation.....	9

### INTRODUCTION

Congratulations on your purchase of a Radial microphone splitter. This manual covers installation and operation for both 8ox and 8cx microphone splitters. We recommend that you take a few minutes to read through this manual in order to familiarize yourself with the many innovative features that are built in.

Should you have questions or applications not covered in this manual, we invite you to log onto the Radial web site at [www.radialeng.com](http://www.radialeng.com) to check the FAQ section for the latest updates. Of course, you can also send us an email at [info@radialeng.com](mailto:info@radialeng.com).

### 8ox DESIGN CONCEPT

The Radial 8ox is an eight channel, balanced microphone splitter in a compact 1RU package that divides the mic signals three ways; to a direct output; a direct output with ground lift; and an isolated output. A high performance bridging transformer is used on the isolated output to eliminate hum and buzz caused by ground loops.

Splitting microphone signals is a straight forward concept. It's most common in sound reinforcement and live recording when the on-stage microphones must be split to feed two mixing consoles. When done improperly, splitting a signal can dull frequency response, lower the output, and worst of all, cause ground loops that product buzz and hum. To avoid these pitfalls, sound reinforcement companies have been building custom "splitter-snakes" for many years.

The 8ox is an off-the-shelf splitter for the rest of us allowing virtually anyone to design and assemble a splitter-snake with plug-n-play simplicity and professional audio quality without the need for custom metal work or complex soldering.

**Radial 8ox**  
Rack Mount Splitter



Radial Engineering Ltd.  
1638 Kebet Way, Port Coquitlam BC V3C 5W9  
tel: 604-942-1001 • fax: 604-942-1010  
email: [info@radialeng.com](mailto:info@radialeng.com) • web: [www.radialeng.com](http://www.radialeng.com)

Specifications and appearance are subject to change without notice.

Radial Engineering Ltd.

[www.radialeng.com](http://www.radialeng.com)

8ox & 8cx Owner's Manual

**BASICS**

**What is a Mic Splitter**

In modern concert production there are often two separate sound systems. The main PA covers the audience or “house” while a monitor system covers the stage so the performers can hear. A third system may be added if the concert is to be recorded. Each system requires it’s own mixing console because the mix that sounds good in the house simply won’t work for the monitors or be suitable for a recording. A mic splitter provides the means to split the original signal from the on-stage microphones and send it to the various systems, main PA, monitors, and recording, so that each can get a clean, unaffected signal directly from the mic.

However, splitting microphone signals is not as simple as just wiring the microphones to all the consoles. Issues such as impedance loading, ground loops and phantom power can degrade the signal and introduce noise. To solve these issues the 8ox uses high performance audio isolation transformers to decouple the signal passing through it and eliminate ground loops that cause hum and buzz in audio systems.

**Inside A Transformer**

A transformer consists of two coils of wire in close proximity to one another wound around a metal core. One coil is the transformers input (primary), the other coil is the output (secondary). A transformer is said to electrically isolate, or decouple, the input from the output because there is no physical connection between the primary and secondary windings. When the primary winding is energized by the mic signal a magnetic field is produced and the lines of force cut across the turns of the secondary winding. Alternating current (AC) which makes up the audio program is transduced from one winding to another through induction. Direct current (DC) which is responsible for buzz and hum in sound systems, is blocked by the transformer eliminating noise caused by ground loops.

**Those Darn Ground Loops**

A ground loop is created when an audio system has multiple paths to ground, often called earth. This situation can occur when two AC powered audio devices, such as two mixing consoles, are plugged into different power circuits and connected together via a signal cable. Both audio devices have a path to ground through the third prong on the AC-mains cable. The signal cable completes the loop by connecting the devices together through the signal cable’s shield.

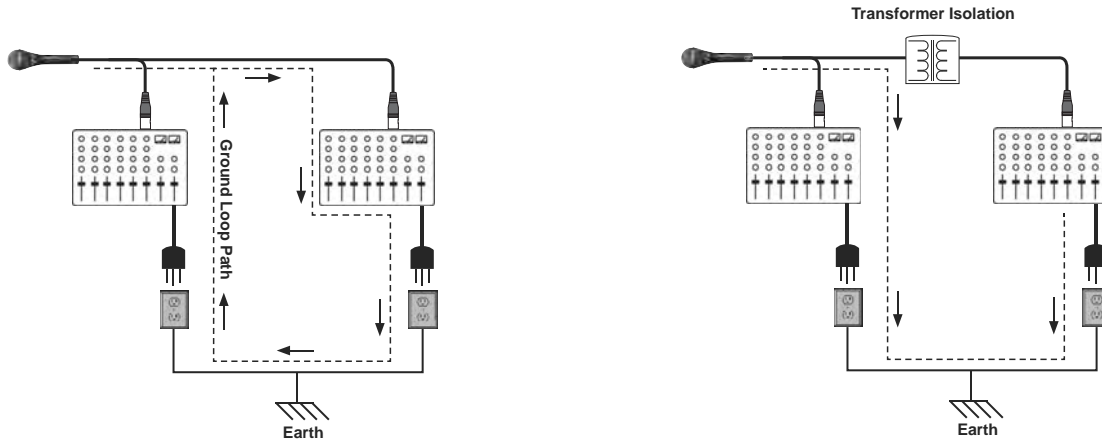
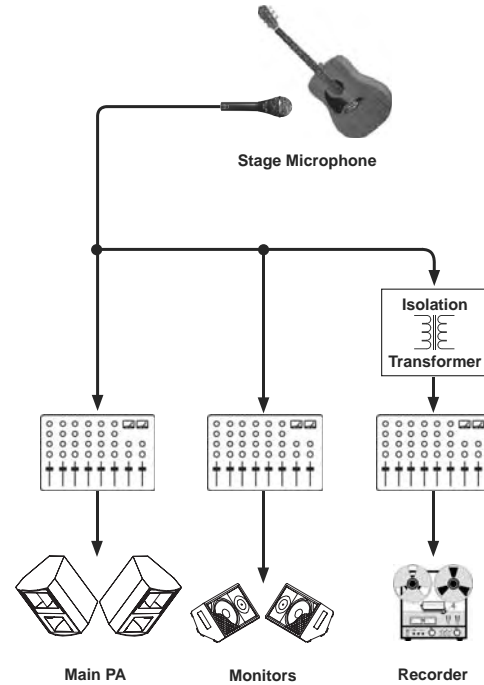

Once the loop is complete there is the electrical potential for DC voltage to flow through it. This potential is caused by the interaction between devices with different ground voltage references and allows unwanted spurious current to flow through the shields of the signal cables. This flow of DC voltage creates noise in the signal wires through induction and capacitance at the base frequency of 50 or 60 Hz (hum) and the upper harmonics of 120 Hz, 240 Hz, etc. (buzz). Isolating or decoupling the audio signal with a transformer at a point between the two devices is the best way to block the unwanted flow of ground-potential currents and eliminate hum and buzz in audio systems.

**Sound Quality**

Besides isolation to prevent hum and buzz, audio transformers must sound brilliant and sound quality is what sets Radial transformers apart. Designed for pro-audio applications they include a host of features not found in general purpose audio transformers. A core material of nickel-iron allows ultra high input levels before saturation, linear frequency response, excellent bandwidth and near zero phase distortion. Consistent unit-to-unit performance is achieved through precision computer controlled winding. The core is sealed inside a mu-metal can which provides enhanced shielding from electromagnetic interference. The built in Bessel low pass filter removes ultrasonic distortion that can mask natural sound and cause ear-fatigue.

## SIGNAL FLOW

Take a moment to follow the signal path through the block diagram below.

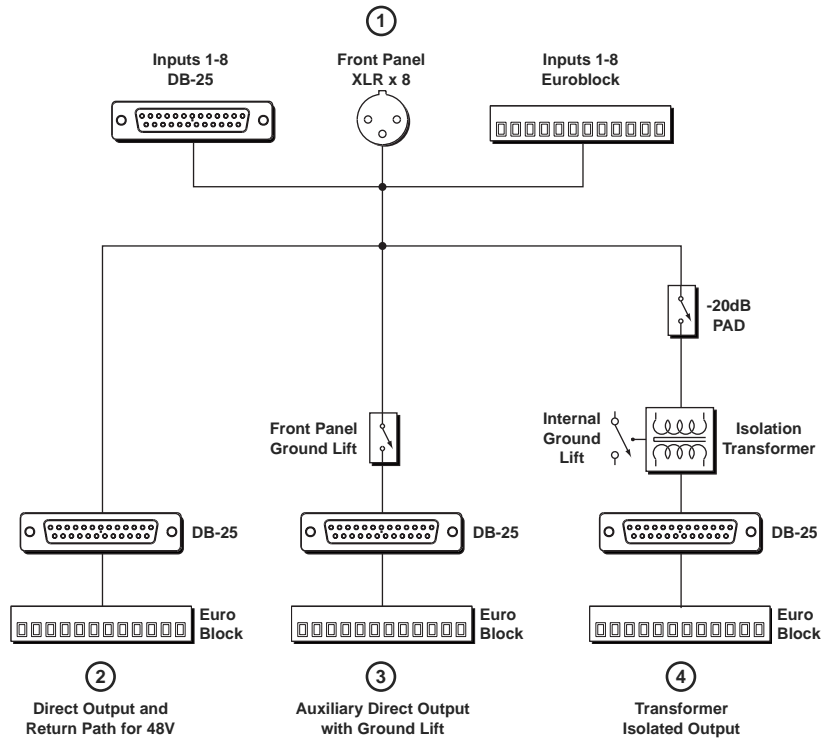

### ① Parallel Inputs

For flexibility, the 8ox has three paralleled inputs.

- Female XLR connectors on the front panel
- 25 pin D-SUB (DB-25) on the rear panel
- Euroblocks screw terminals on the rear panel (Set of eight Euroblocks terminals sold separately, Order # R800 8050).

### ② Direct Output

The DIRECT output is the primary “straight through” output and provides a return path for 48V phantom power for condenser microphones and active direct boxes. In the diagrams we refer to the Main FOH console as connected to the DIRECT output. In fact it doesn't matter which console, main or monitor, is connected to DIRECT as long as it is the sole console which will supply phantom power. The DIRECT output is paralleled to DB-25 and Euroblocks terminals for flexibility.

### ③ Auxiliary Direct Output with Ground Lift

The DIRECT OUT WITH GROUND LIFT is a auxiliary output that uses eight front panel switches to lift the ground. This output may be patched to another audio system that may or may not be transformer isolated itself. The DIRECT WITH GROUND LIFT output is paralleled to DB-25 and Euroblocks terminals.

### ④ Isolated Output

The ISOLATED outputs uses eight precision audio isolation transformers to decouple the mic signals from the DIRECT outputs. This output may be patched to a separate audio system without creating ground loops. The ISOLATED output is paralleled to DB-25 and Euroblocks terminals.

#### -20dB PAD

The front panel PAD switch can prevent transformer overload when connecting high output devices like synthesizers and drum machines. Engaging the PAD reduces the level by -20dB for that particular channel at the ISOLATED output.

#### Radial Transformer

After the PAD the signal is fed to the isolation transformer where the mic signal is decoupled to eliminate noise from ground loops. For the most flexibility when designing technical ground systems, each transformer features an internal switch allowing the signal ground to connect around the transformer.

#### RF Filter (not shown in the diagram)

The three paralleled inputs employ a RF network filter on their ground paths to prevent unused inputs from acting like antennas when the ground is lifted. Any radio frequencies picked up by an open pin will be shunted to ground.

8OX FEATURE SET

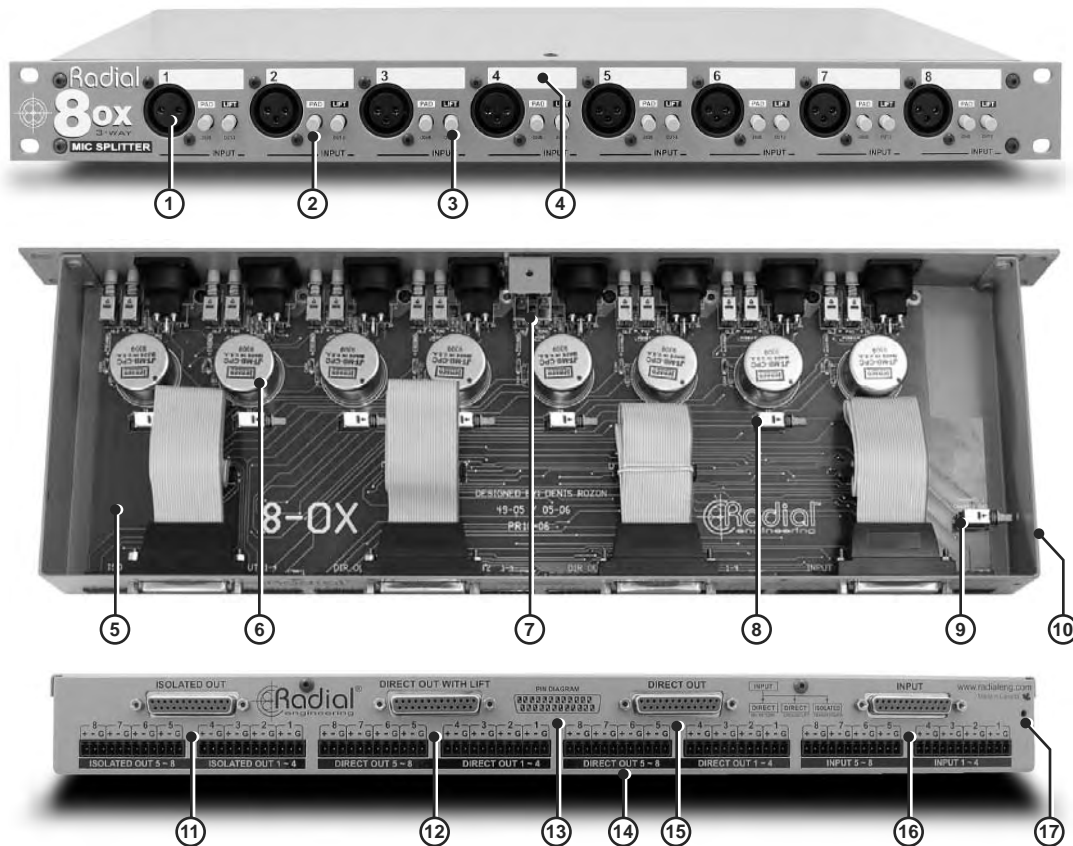

1. **XLR Inputs** - Front panel female XLR jacks allow easy connection of individual signals. Rugged, glass-reinforced nylon construction for reliable connections.
2. **PAD -20dB** - Prevents transformer overload when connecting high output devices. Only the ISOLATED output is affected by the PAD.
3. **Front panel Lift switch** - Disconnects the ground path at the DIRECT WITH GROUND LIFT auxiliary output. Using the front panel ground lift can eliminate ground loop noise between equipment connected to the 8ox direct outputs.
4. **Easy ID label zones** - For dry-erase markers or wax pencil identification. Handy when using several 8ox at a time.
5. **Military Grade PCB** - The dual layer circuit board is manufactured with plated through holes and secured with 8 standoffs.
6. **Transformers** - Each transformer is mounted directly on the PCB in close proximity to the input for the shortest possible signal path. Choice of standard Radial or optional Jensen transformers.
7. **Heavy-duty Switches** - Front panel switches are metal encased and rated at 20,000 operations.
8. **Internal Ground Lift** - Each channel features an internal switch that, by default, is set to "lifted" so the transformer can isolate ground potential voltages. It may be used by system designers to accommodate specific grounding schemes when desired.
9. **Internal Chassis Ground Lift** - Input connectors are 100% isolated from the chassis, but an internal switch is provided to connect signal ground (pin-1) to the chassis without modifying the 8ox. By default, this switch is factory set to "lifted" allowing the chassis to "float" ungrounded and should remain this way unless a specific grounding scheme requires the signal ground to be tied to the chassis.

10. **14-Gauge Chassis** - Made extra tough with heavy gauge steel and welded corners to provide excellent shielding and durability. Finished in baked enamel.
11. **Isolated Output** - This output is transformer isolated to block noise caused by ground loops and is wired in parallel to DB-25 and Euroblocks terminals.
12. **Direct With Ground Lift** - This is an auxiliary output wired in parallel with the DIRECT output. The signal grounds may be disconnected using the front panel LIFT switch. This output is wired parallel to the DB-25 and Euroblocks terminals.
13. **DB-25 Pin-out Diagram** - The pin-out for the female DB-25 connector is diagramed on the rear panel. All DB-25 connectors follow the Tascam standard for eight channel analog signal interface.
14. **Euroblock Sockets** - These panel sockets receive 12-pin Euroblock screw terminals. Each Euroblock connects four channels with bare wire termination and facilitate custom options like interfacing a connector panel or multi-pin disconnect. Euroblocks screw terminals are optional and must be ordered separately. (Radial order # R800 8050)
15. **Direct Output** - This output passes signal through the 8ox and provides the return path for phantom power. This output is wired parallel to the DB-25 and Euroblocks terminals.
16. **Rear Inputs** - The rear panel DB-25 and Euroblock inputs connect all eight channels and are wired parallel to the front XLR connectors.
17. **Chassis Ground** - Ground screw connection point used in conjunction with the internal chassis lift switch to bond the 8ox to earth.

## CONNECTING THE 8ox

### 8ox Inputs

You can connect mics and direct boxes to the 8ox using the front panel XLR inputs, or the rear panel DB-25 and Euroblocks terminals. Which input you choose to use will depend where the 8ox is located and what you are connecting to it. For instance, individual microphones may be connected directly via the front panel XLRs (1), or a multi-channel snake may be used to connect to the DB-25 inputs (2). Finally, a wall-mounted panel of XLRs may be connected to the Euroblock inputs with a multi-channel snake cable (3).

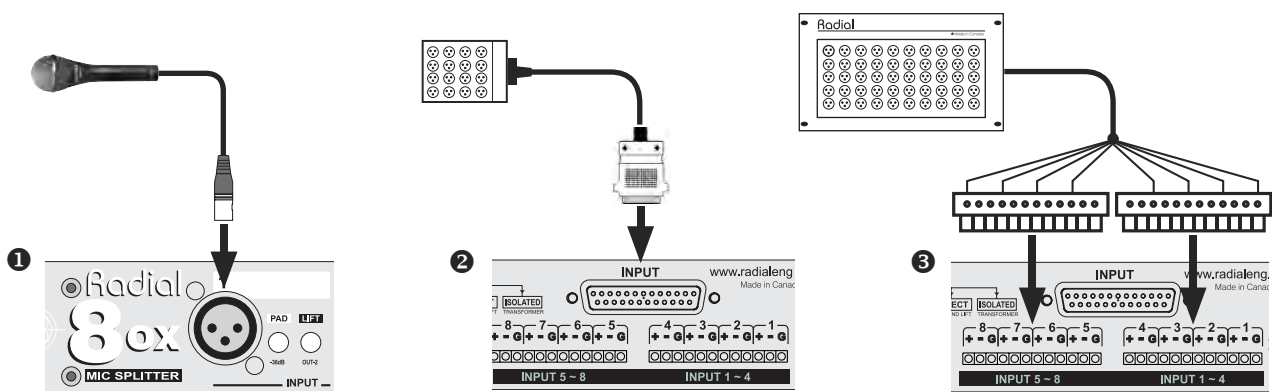

### Connecting the DB-25 I/O

The DB-25 connectors on the rear panel use the TASCAM pin-out standard for analog audio. Connecting the 8ox to devices equipped with DB-25 connectors like digital multi-track recorders and mic preamps is simply a matter of using compatible DB-25 audio cables. Radial balanced DB-25 cables are a perfect match for the 8ox and can be ordered in standard or custom lengths.

The pin-out diagram is silk-screened on the rear panel for reference and represents the panel-mount female pin-out. To make your own interface DB-25 cables follow the pin-outs below for male and female connectors.

Female DB-25 Pin-out (Panel View)

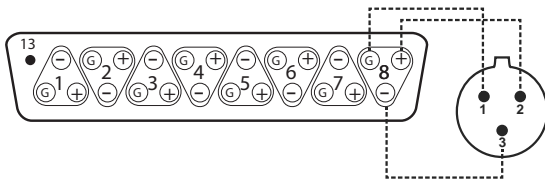

Male DB-25 Pin-out (Cable View)

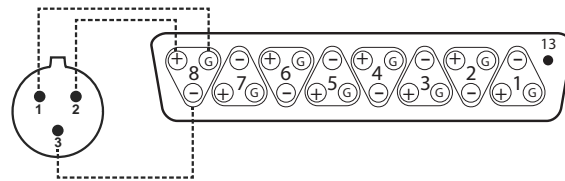

### Connecting the Euroblock Terminals

Euroblock, or European style terminal blocks, also called Phoenix blocks, are removable screw terminal connectors. The Euroblock connector requires no soldering to terminate. Instead, the wire is stripped, inserted into slots in the connector, and locked into place with a standard screwdriver. The connector then mates with the socket. Pin termination for the Euroblock terminals are clearly marked on the rear panel.

Referring to the pins on an XLR connector:

- Connect pin-1 (GROUND) to the G terminal.
- Connect pin-2 (HOT) to the + terminal.
- Connect pin-3 (COLD) to the - terminal.

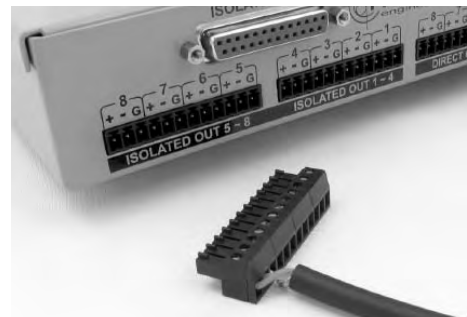
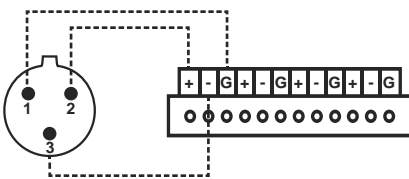

**NOTE:** Euroblocks are optional equipment and must be ordered separately (Radial order number R800 8050).



### Connecting Two Mixing Consoles

This is the most basic 8ox set up and allows the MAIN PA and MONITOR consoles to have access to the stage microphone signals.

The MAIN PA console connects to the DIRECT output and supplies 48V phantom power to the mics and active direct boxes.

The MONITOR console uses the ISOLATED output and is therefore electrically decoupled from the first console. The MONITOR console may be powered from a separate AC-mains circuit without creating ground loops.

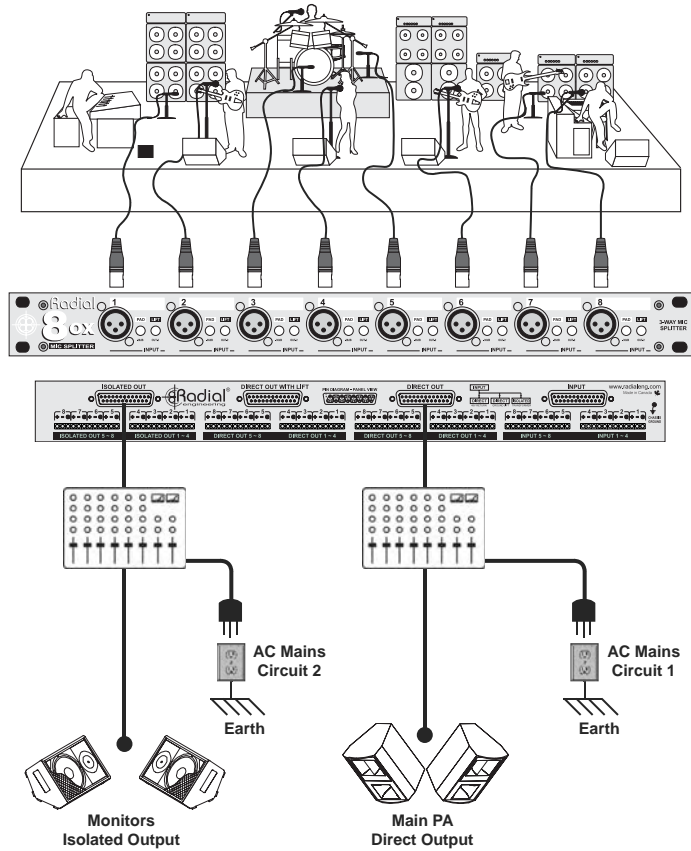

### Connecting Three Mixing Consoles

This advanced setup connects three consoles to an 8ox.

The MAIN PA console connects to the DIRECT output and the MONITOR console to the auxiliary DIRECT with LIFT output. In order to avoid hum and buzz from ground loops these consoles should be powered from the same AC main circuit or a power distribution system designed to prevent ground loops from forming.

A third RECORDING console connects to the isolated output and is therefore electrically decoupled from the MAIN PA and MONITOR consoles. The RECORDING console may be powered from a separate AC mains circuit without creating ground loops.

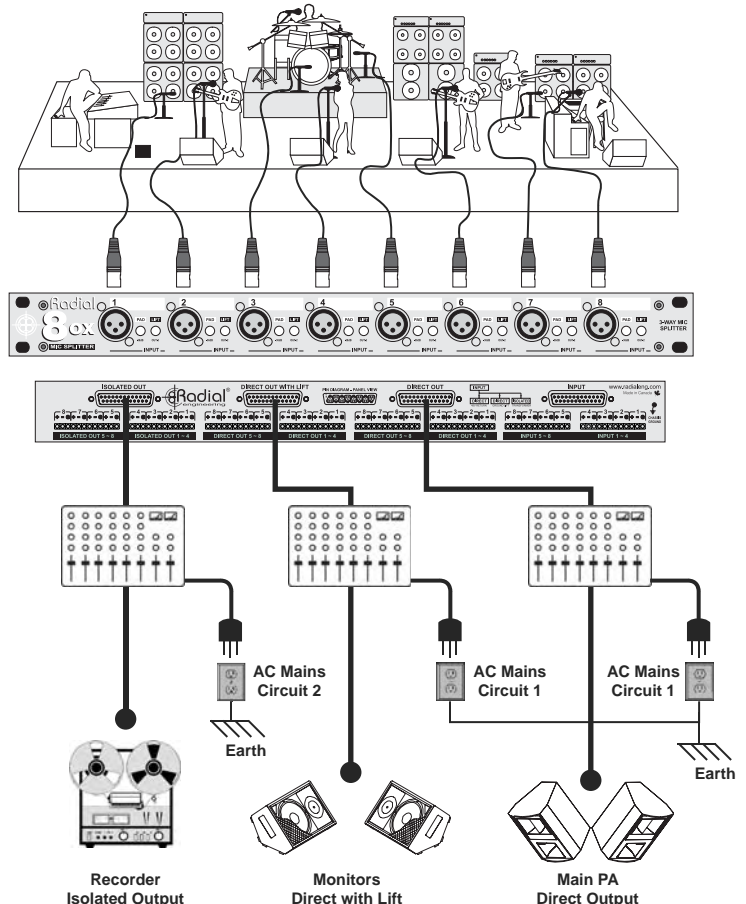

The Radial 8ox features two internal grounding options that will be of interest to system engineers when integrating the 8ox into complex audio-visual systems. Most users will not need these options and can accept the factory default settings.

**Internal Ground Lift - Each Channel**

Each channel's transformer features an internal ground switch that re-connects the ground around the transformer. It may be used on a per-channel basis to accommodate specific grounding needs. For example, it may be necessary to set this switch to closed for devices that have a floating ground like battery powered laptop computers or devices powered with an AC to DC adaptor.

By default this switch is set to open, or lifted (out position) so the transformer can decouple equipment connected to the ISOLATED outputs. Pushing the switch in (closed) will connect the input signal ground to the output ground at the ISOLATED output for that channel.



Each channel has a lift switch directly below the transformer.

**Internal Chassis Ground Lift - All Channels**

All tconnectors are 100% isolated from the steel chassis allowing chassis and signal ground to be kept separate. However, an single internal switch is provided to connect the pin-1 cable shields to the chassis without modifying the 8ox. By default, this switch is factory set to open or "lifted" allowing the chassis to "float" ungrounded.

Should a specific grounding scheme require the cable shields to be bonded to the chassis simply set this switch to closed (pushed in position). The switch may be accessed through a small hole in the side of the steel chassis or by removing the top cover. The chassis ground switch does not effect the isolation provided by the transformer at the ISOLATED output.

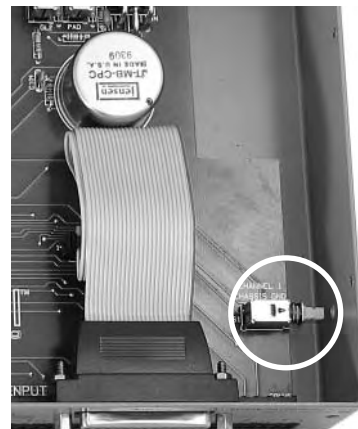

Access the internal chassis ground lift switch through a small hole in the side of the chassis.

On the rear panel a ground screw provides a convenient point to bond the chassis. Use a heavy gauge solid copper wire to bond the 8ox chassis to your technical ground.

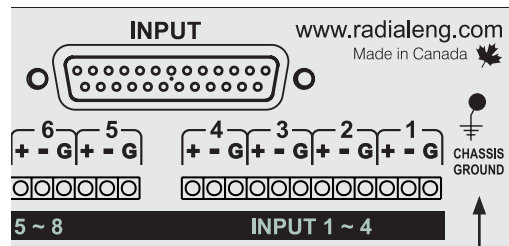

Rear panel chassis screw used for bonding to technical ground.

**RADIAL 8cx INTRODUCTION**

Congratulations on your purchase of a Radial 8cx microphone splitter. The Radial 8cx is an easy to use eight channel splitter in a contractor friendly install package. Like it's rackmount cousin, the 8cx divides the mic signals three ways; to a direct output; a direct output with ground lift; and an isolated output. A high performance audio isolation transformer is used to eliminate hum and buzz caused by ground loops.

**8cx DESIGN CONCEPT**

The 8cx allows sound contractors to quickly build and install a custom mic splitter with excellent sonic performance. The 8cx is ideally suited for permanent install where it can be incorporated into the electrical conduit installed by the electrical trades.

Typically, 8cx splitters are mounted in an electrical box located in a utility room or under the stage. The 8cx is designed to fit in standard size NEMA electrical junction boxes. Six 8cx splitters can easily fit into a 24" x 24" enclosure for a 48 channel system.

The 8cx connects to XLR interface panels located around the theater through the electrical conduit. For example, microphones may connect to stage-left and stage-right XLR input panels, another on-stage panel may be used to interface the monitor console while a panel in the house seating connects the main PA console.

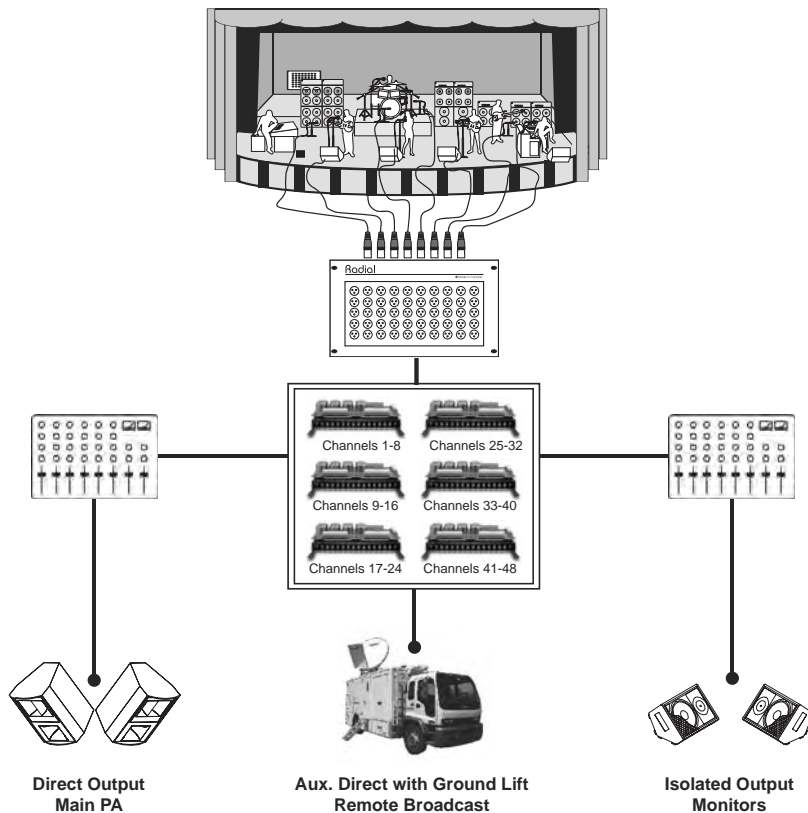
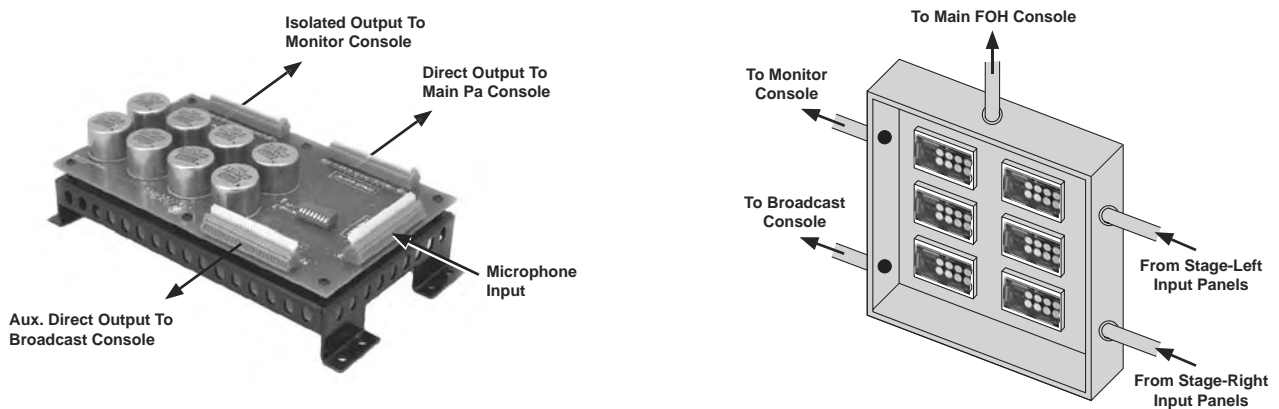

**8cx FEATURE SET**

1. **Skeleton Frame** - The 9.5" x 5" frame is constructed of 14-gauge steel and serves several functions. It's built in stand-offs allow cable to pass underneath. It can be used as a cable tie-down point on four sides.
2. **Radial Transformer** - Each transformer is mounted directly on the PCB in close proximity to the input for the shortest possible signal path.
3. **WAGO Terminal** - Used for all the I/O connection, the WAGO terminal uses a spring clip to clamp down on the wire for a secure termination.
4. **Ground Lift DIP Switch** - Each channel feature a ground DIP switch that disconnects the signal ground at the DIRECT WITH LIFT output. It may be used to break ground loops between devices connected to the DIRECT and auxiliary DIRECT WITH LIFT outputs.
5. **Inputs** - Eight channels of balanced signals connect to the 8cx input via WAGO spring terminal.
6. **Legends** - The PCB is clearly marked with termination information above each WAGO terminal. All information required for terminating is screened right on the PCB.
7. **Direct Output** - This output passes signal straight through the 8cx and is usually the return path for phantom power.
8. **Direct with Lift** - This auxiliary output is wired in parallel with the DIRECT output. The signal ground may be lifted using the DIP switch to eliminate hum from ground loops.
9. **Isolated Output** - This output is transformer isolated to block hum and buzz caused by ground loops.
10. **Military Grade PCB** - The dual layer circuit board is manufactured to military standards with plated through holes.

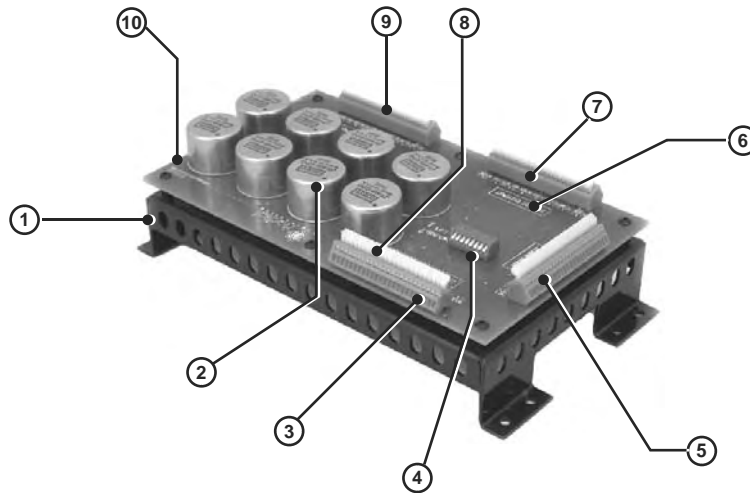

**MOUNTING AND TERMINATING THE 8CX**

The distinctive 'skeletal' frame is easy to mount using the four, pre-drilled mounting feet. When terminating the perforations around the frame offer cable management tie-downs and built-in stand-offs allow cables to pass underneath. Tie off cable bundles at the frame to provide strain relief at the WAGO connectors.

To ensure proper shielding from external noise it is important that the enclosure be bonded to ground (earth). Conduit installed by electrical trades is usually bonded to the buildings main ground which is ideal for the 8cx. If you are mounting in another type of metal enclosure ensure it has a connection to ground. If you are unsure, consult your local electrical codes.

**Connecting the WAGO Terminals**

The 8cx install splitter employs four WAGO spring clamp terminals to facilitate quick on-site connection. These accept wire gauges from 14awg to 28awg and feature a clamping action that embeds the wire for a solid and dependable contact. For neat installations that facilitates long term servicing, it's a good idea to plan out the cable paths in advance. Always tie-off cable bundles to the 8cx frame for strain relief.

Strip off about a quarter inch of insulation from the wire. A small screwdriver is used to push open a terminal clamp on the WAGO connector. Insert the wire lead and let go. The wire is clamped in. Visually inspect where the wire enters the WAGO connector and ensure that it is inserted far enough that no bare copper is exposed or can touch the wires of other channels. The pin-out legend is silk screened on the PCB above each WAGO connector.

**INTERNAL GROUNDING OPTIONS**

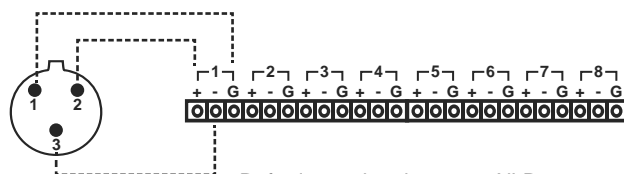
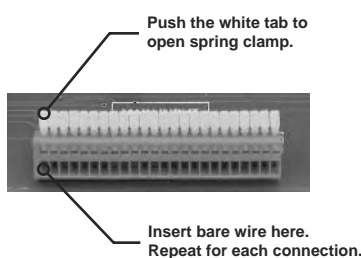

- Referring to the pins on an XLR connector:
- Connect pin-1 (GROUND) to the G terminal.
  - Connect pin-2 (HOT) to the + terminal.
  - Connect pin-3 (COLD) to the - terminal.